

For Mardome Trade on to  
Sloping or 300mm Kerb  
See Page 2 overleaf

**Fixing Quantities**

Length of Nominal Dome Side (mm)	Number of fixings per side
600, 750	2
900, 1050, 1200	3
1350, 1500, 1650	4
1800, 1950	5
2100, 2250	6
2400	7

(All fixings supplied in packs of 5.)

**Installation Instructions**

**a** Install roof covering to cover existing upstand in accordance with manufacturer's installation recommendations.

**Ⓢ N.B.** It is important that there should be no excessive build up of layers, the top surface should be level and free from any protrusions or projections which may prevent adequate weather proofing.

For Unvented option, go to **d**.

**b** Mastic/Silicone around the edge of the upstand opening.

**c** For *Ventilated Version*: Correctly place vented kerb, ensuring it is located squarely to the upstand. Fix vented kerb to the existing upstand using the 125mm vented kerb fastener.

**d** Carefully remove dome from it's packaging and place squarely on top of the completed upstand/secured vented kerb.

**⚠** ONLY use the fixings supplied!

**⚠** DO NOT over drive fasteners!

**e** Fix the dome to the vented kerb or existing upstand.

Use the supplied dome fasteners through the metal washer (if supplied) and the pre-fitted fastener buttons.

The Dome is fully secured to the vented kerb/builders upstand as soon as fastener buttons are gripped to the dome and do not spin by hand.

**f** Fit fastener caps to each pre-fitted fastener button, ensuring that the key-way is aligned as shown below.

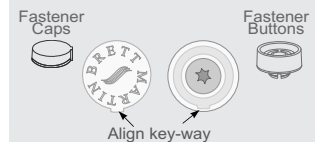

**Mardome Contents**

**i** Please unpack and check that all correct parts are included and undamaged.

All Mardome Trade (Unvented or Vented)

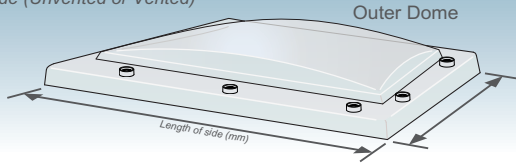

Plus, for Ventilated Version Only

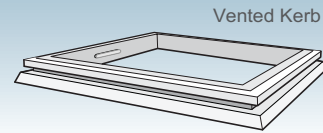

With this assembly, you will receive:  
**Dome Fixings**

**i** Dome Fasteners

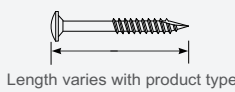

**ii** Fastener Caps



**iii** Washers (if supplied)\*



\*Not supplied for cassette construction

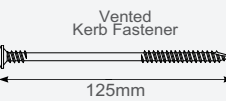

**Mardome Installation**

**⚠** Please note that all Health and Safety Regulations must be followed on site throughout the installation process.

*Unvented dome on to existing upstand*

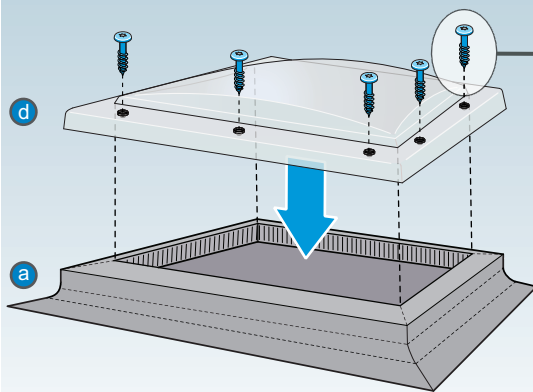

*Vented dome on to existing upstand*

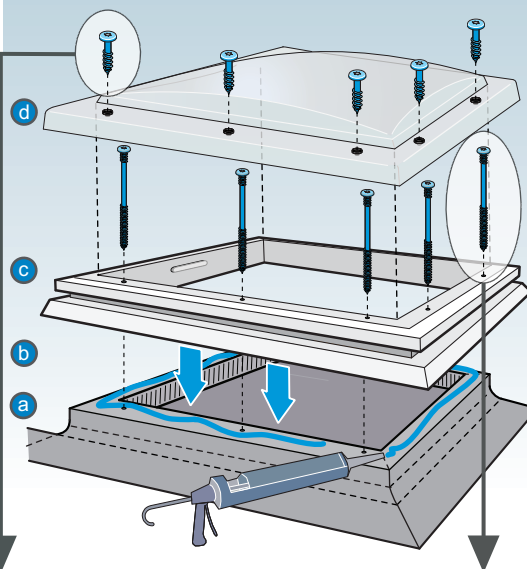

**Dome Installation Details**

**e f** For All Mardome Trade Domes

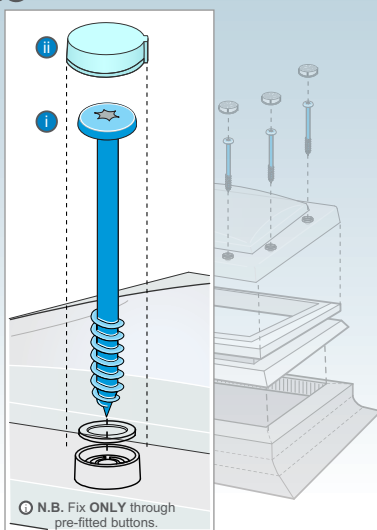

**Ⓢ N.B.** Fix ONLY through pre-fitted buttons.

*Kerb Fixing*

**c** Ventilated Version Only

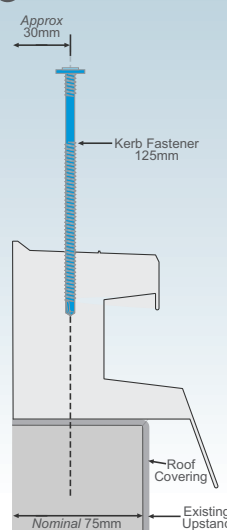

**Ⓢ TECHNICAL SUPPORT:** For any technical information/queries please contact your supplier.

**Fixing Quantities**

Length of Nominal Dome Side (mm)	Number of fixings per side
600, 750	2
900, 1050, 1200	3
1350, 1500, 1650	4
1800, 1950	5
2100, 2250	6
2400	7

(All fixings supplied in packs of 5.)

**Installation Instructions**

- a** Mastic/Silicone around the edge of the roof opening and correctly position the kerb, ensuring it is located squarely over the roof opening.
- b** Fix kerb to the roof using the 55mm kerb fastener.  
  
See above **Fixing Quantities** table for the correct quantity of fastenings required for the size of the dome.  
  
**i** **N.B.** Length of side refers to the nominal dome size (equivalent to inside base of kerb foot).
- c** Remove and retain kerb label then install roof covering up to lip. Install in accordance with manufacturer's installation recommendations.  
  
**i** **N.B.** Never apply direct heat or naked flame to the rooflight! Ensure the roof covering **will not** foul clamp or cover trim!
- d** (If Supplied) Lock the membrane clamp down fully, as shown.
- e** Carefully remove dome from its packaging and place squarely on top of the secured kerb, ensuring equal overhang on all four sides.

**!** ONLY use the fixings supplied!

**!** DO NOT over drive fasteners!

**f** Fix the dome to the kerb.

Use the supplied dome fasteners through the metal washer (if supplied) and the pre-fitted fastener buttons.

The Dome is fully secured to the kerb as soon as fastener buttons are gripped to the dome and do not spin by hand.

**g** Fit fastener caps to each pre-fitted fastener button, ensuring that the key-way is aligned, as shown.



**!** N.B. Fix ONLY through pre-fitted buttons.

**Mardome Contents**

**i** Please unpack and check that all correct parts are included and undamaged.

All Mardome Trade (Unvented or Vented)

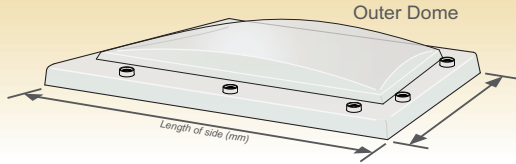

All Mardome Trade (Unvented or Vented)

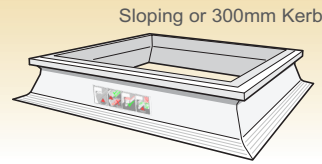

With this assembly, you will receive:  
**Dome Fixings**

- i** Dome Fasteners  
  
Length varies with product type
- ii** Fastener Caps
- iii** Washers (if supplied)\*  
  
\*Not supplied for cassette construction

With this assembly, you will receive:  
**Kerb Fixing**

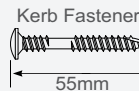

**Mardome Installation**

**!** Please note that all Health and Safety Regulations must be followed on site throughout the installation process.

Unvented or Vented dome on to sloping or 300mm kerb

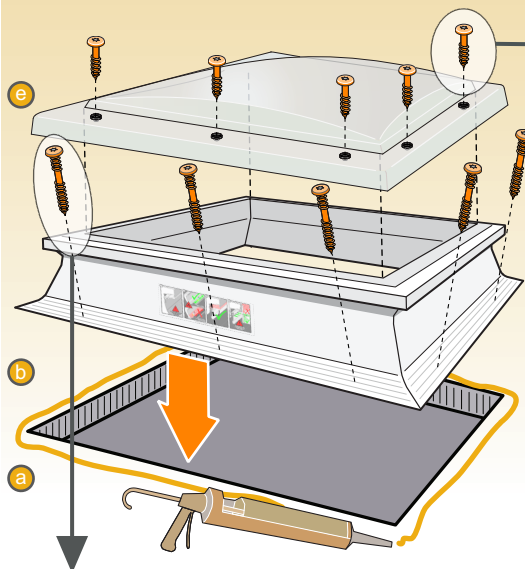

**c** Roof Covering Installation

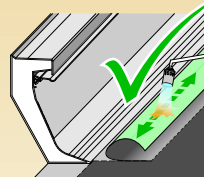

**WARNING:**  
Never apply direct heat or naked flame to the roof light!

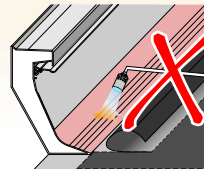

**d** **IMPORTANT:**  
Roof Covering Clamp Locking (If Supplied)\*



Push along line as shown to lock. DO NOT push on soft area!

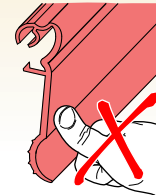

\*Only supplied on 216mm and 300mm kerbs

**Kerb Installation**

**b c** All Mardome Trade (Unvented or Vented)

- Kerb
- Structural Member
- Roof Covering
- Insulation

Sloping Kerb (type varies with specification)

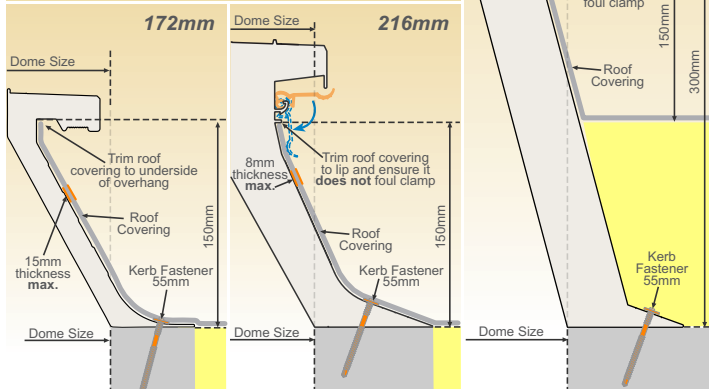

**Dome Installation**

**f g** For All Mardome Trade Domes

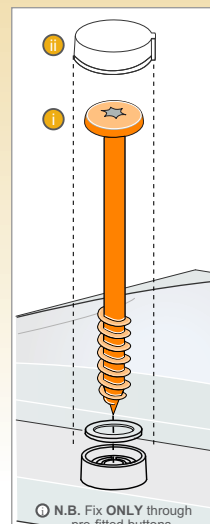

**!** TECHNICAL SUPPORT: For any technical information/queries please contact your supplier.